

MODELE	POIDS A VIDE	CONTENANCE	CHARGE AU SOL EN EAU	PUISSANCE MAX	CONSOMMATION MAX (sous 230V)	DIMENSIONS
R200	300 KG	700 L	450 KG/M <sup>2</sup>	9000 W	40 A	2000mm 780mm

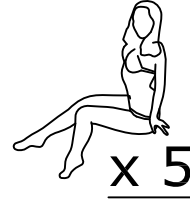

**Installation hors sol**

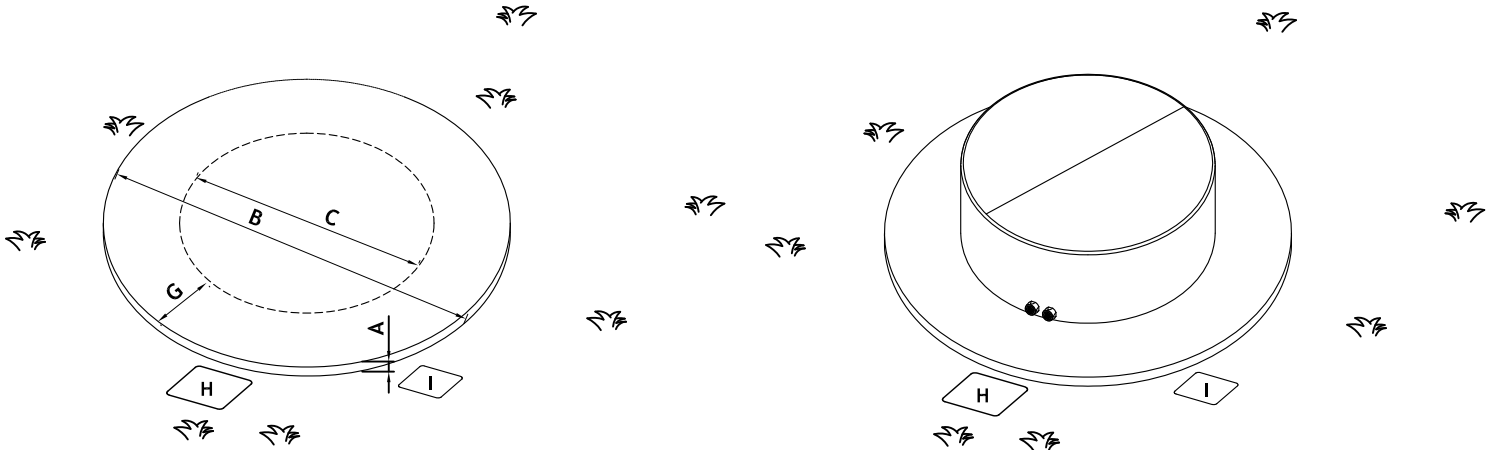

**Installation encastrée**

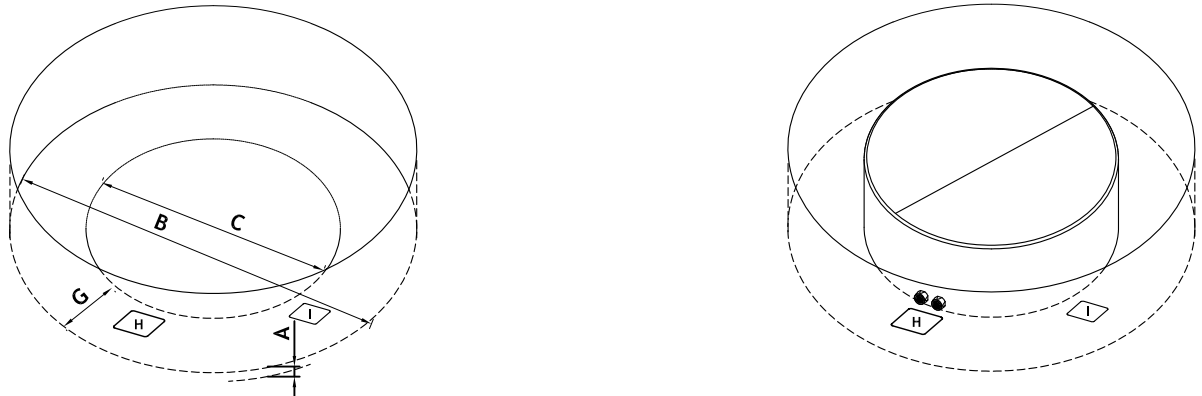

- A : Hauteur dalle béton >100mm**
- B : Diamètre de la dalle : 2xG + C**
- C : Diamètre de votre SPA**
- G : Zone technique : >600mm**
- H : Attentes évacuations**
- I : Arrivée électrique**

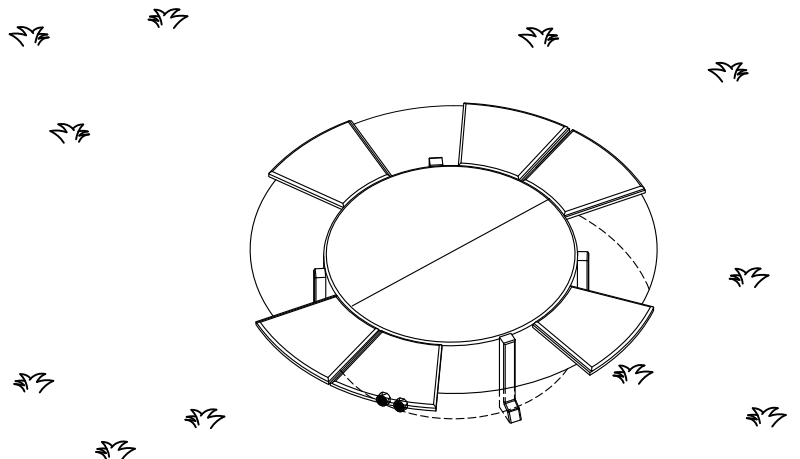

**R200**

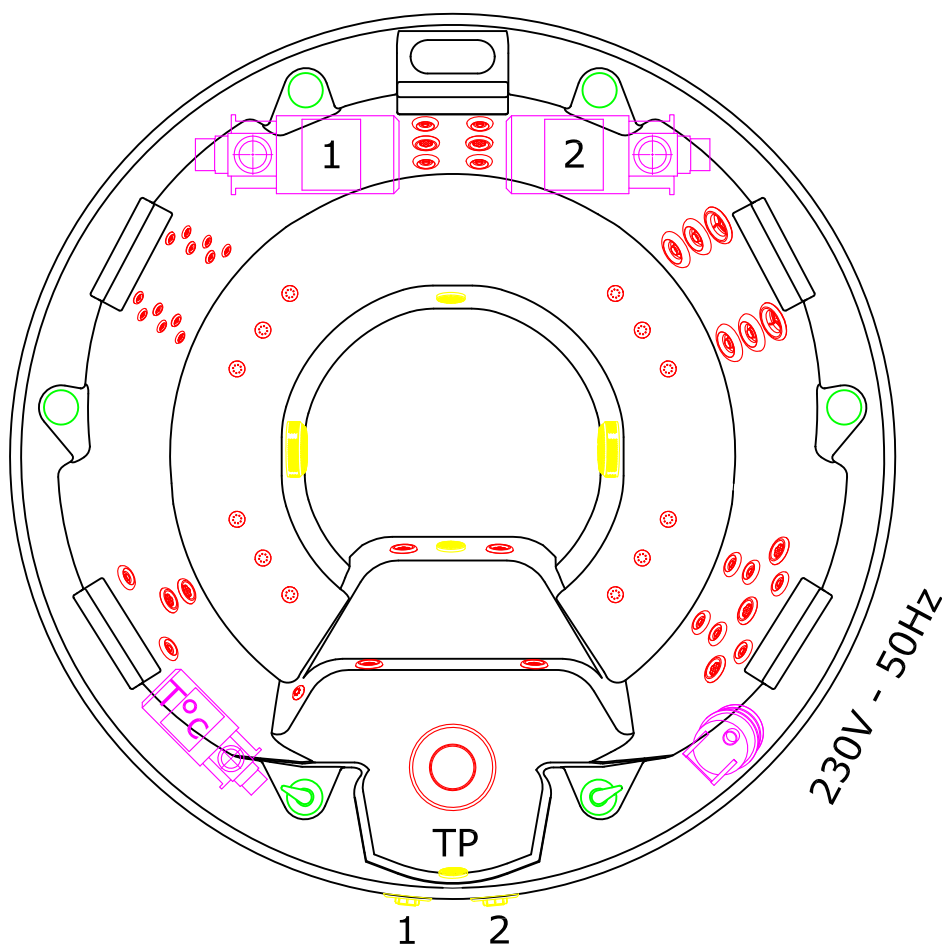

DOCUMENTATION NON CONTRACTUELLE

**LEGENDE**

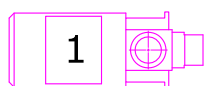

Pompe de massage 1

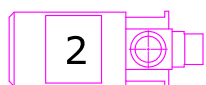

Pompe de massage 2



Pompe de recirculation  
+ Réchauffeur



Soufflerie



Filtre



Flux d'air



Flux d'eau

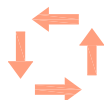

Sens de l'eau



Evacuation de vidange



Evacuation de trop plein



Crépine de recirculation



Crépine de trop plein



Crépine de massage



Venturi



Inverseur



Buse



Injecteur

DOCUMENTATION NON CONTRACTUELLE

**POMPE DE MASSAGE 1**

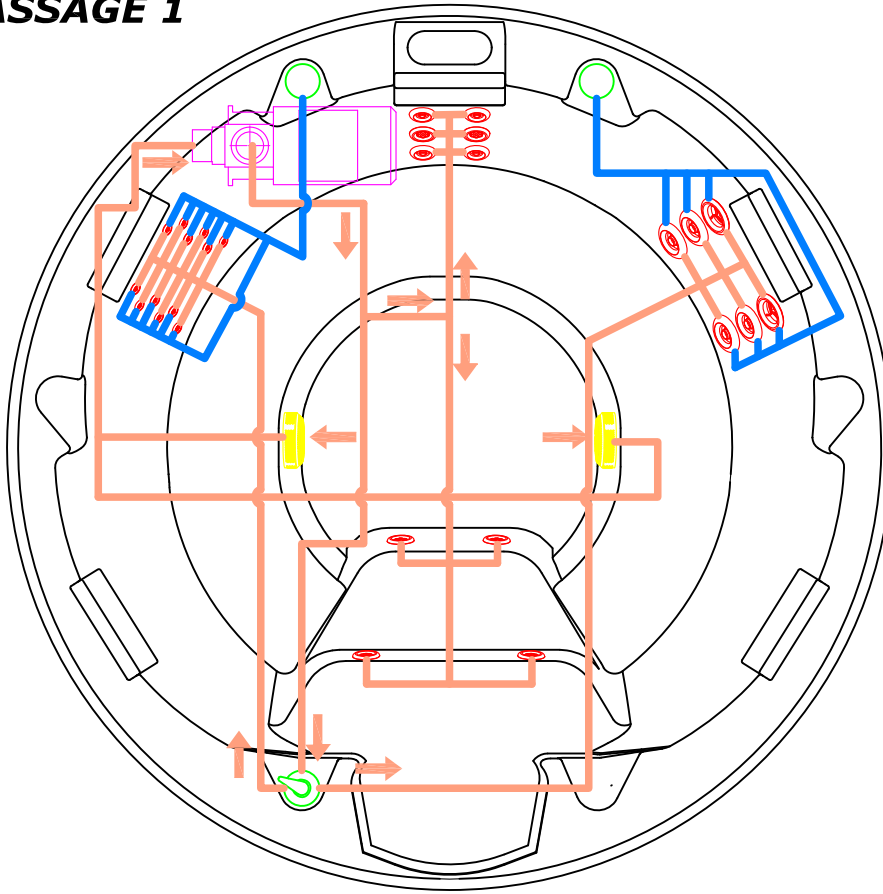

DOCUMENTATION NON CONTRACTUELLE

**POMPE DE MASSAGE 2**

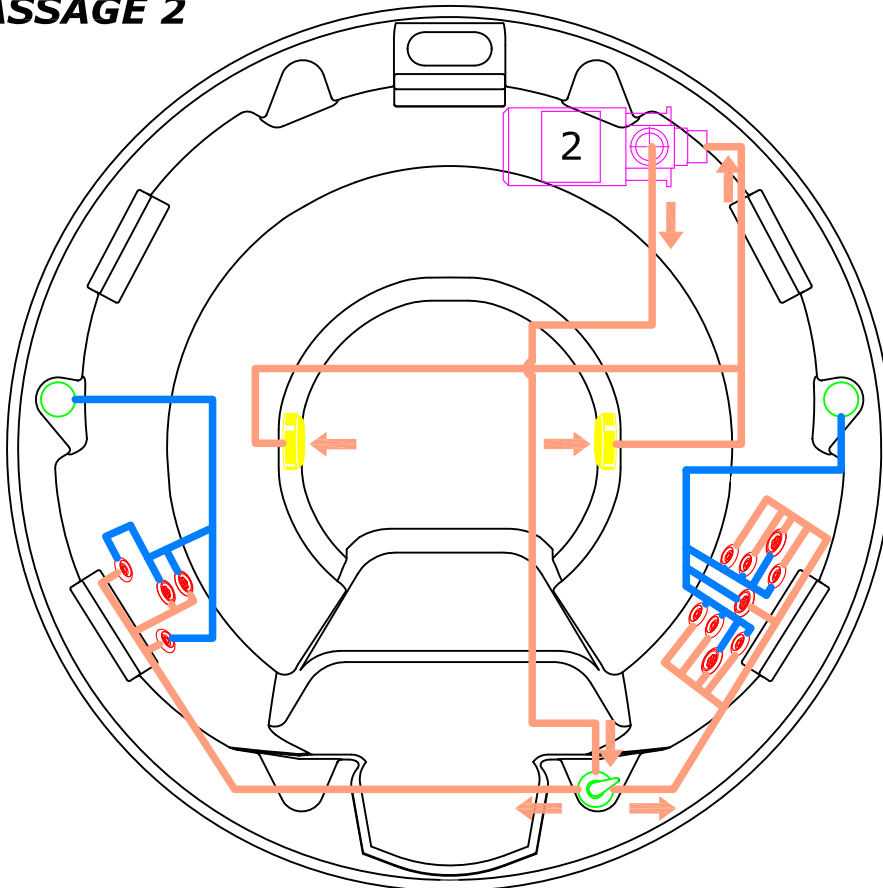

DOCUMENTATION NON CONTRACTUELLE

**POMPE DE RECIRCULATION**

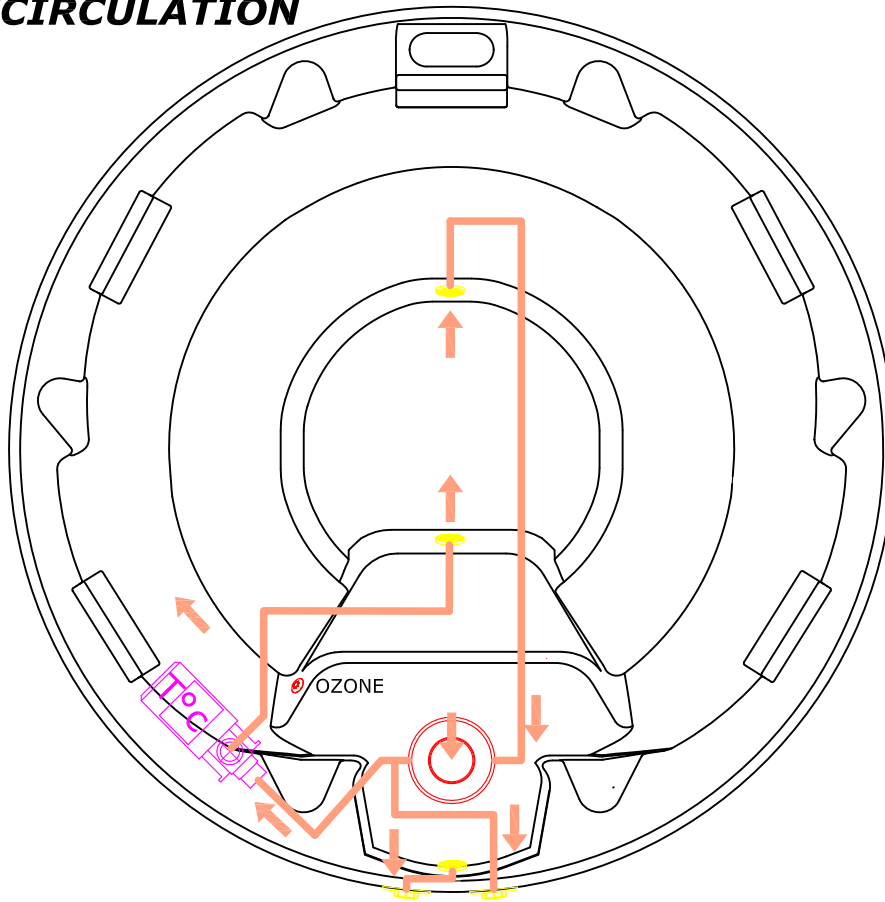

DOCUMENTATION NON CONTRACTUELLE

**SOUFFLERIE**

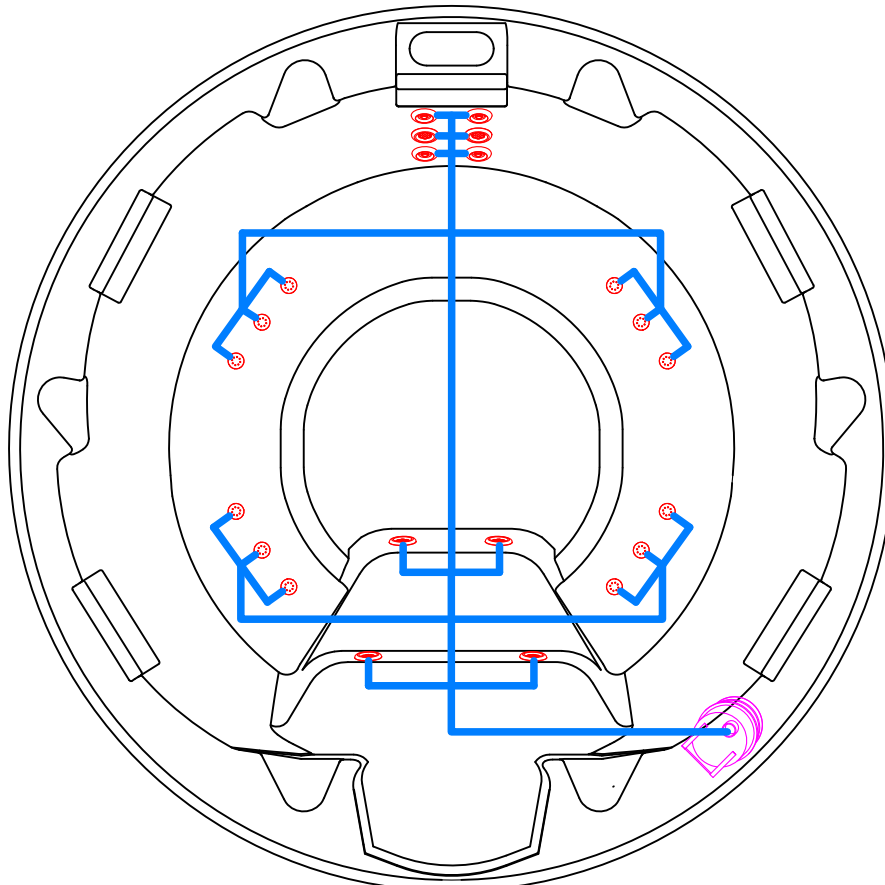

DOCUMENTATION NON CONTRACTUELLE